



Burokrat

NEW EXECUTIVE CHAIRS 2018



Part 1



MINIMUM OF DETAILS – MAXIMUM COMFORT

Office is a place for work, thinking, creating of strategies and for quality time with yourself. That's why every detail of the office space should please your eyes and motivate for success. TM «Burokrat» has been taking care of your comfort either at home or in office for more than 20 years. Office furniture delivery requires special approach: office furniture customers are our good friends and regular clients as we are taking care not only of creating working place but of creating cozy atmosphere at home and in the office.

So what should be the most comfortable home and office furniture? It is a very important aspect as it's much better to meet partners and make deals in a relaxed atmosphere. TM «Burokrat» assortment is more than 100 chair models, among which you can find respectable executive chairs, ergonomic decisions for desk officers, visitors chairs which are reliable, functional and durable. Wide choice of colour solutions and materials give us an opportunity to produce office chairs meeting all individual requirements.

TABLE OF CONTENTS

	Modern executive chair Burokrat T-898	2		Modern executive chair Burokrat CH-823AXSN	18
	Modern executive chair Burokrat T-898_Or-10	4		Modern executive chair Burokrat T-995HOME	20
	Modern executive chair Burokrat KB-6SL	6		Modern executive chair Burokrat CH-839	22
	Modern executive chair Burokrat KB-10Lite	8		Modern executive chair Burokrat CH-868LT	24
	Modern executive chair Burokrat KB-10	10		Modern executive chair Burokrat T-9910N	26
	Modern executive chair Burokrat DOMINUS	12		Modern executive chair Burokrat CH-S840N	28
	Modern executive chair Burokrat KB-9ECO	14		Modern executive chair Burokrat CH-825A	30
	Modern chair Burokrat VIKING-8	16		Modern executive chair Burokrat CH-824B	32

MODERN EXECUTIVE CHAIR

Burokrat T-898



Modern executive chair Burokrat T-898

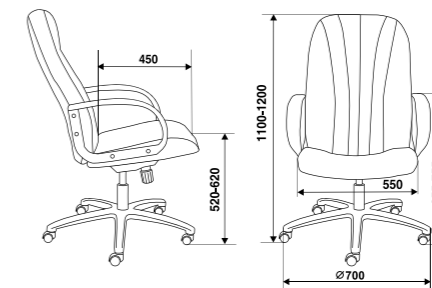

UPHOLSTERY MATERIAL
Artificial leather

PACKAGE

Weight: 15,25 kr
Volume: 0,177 m³
Dimensions (mm):
825x320x670

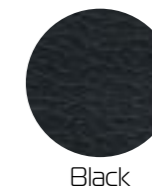
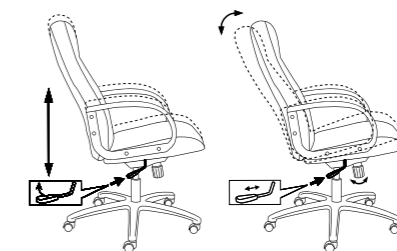

Black

CONSTRUCTION

- Swivel tilting mechanism with weight adjustment, tilting and tilt lock at upright position
- Height adjustment (gas lift)
- Plastic armrests
- Plastic base
- Weight limit - 181 kgs



Item number

PartNo

1129534

T-898/#B

MODERN EXECUTIVE CHAIR

Burokrat T-898_Or-10



Modern executive chair Burokrat T-898_Or-10

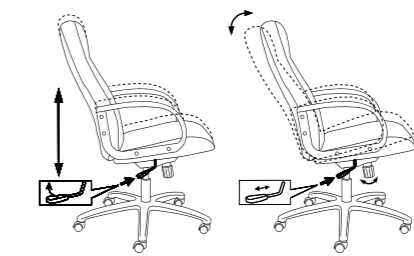
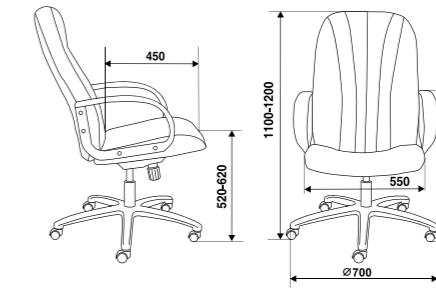

UPHOLSTERY MATERIAL
Artificial leather

PACKAGE
Weight: 15,25 kr
Volume: 0,177 m³
Dimensions (mm):
825x320x670



White

CONSTRUCTION

- Swivel tilting mechanism with weight adjustment, tilting and tilt lock at upright position
- Height adjustment (gas lift)
- Plastic armrests
- Plastic base
- Weight limit - 181 kgs



Item number

PartNo

1129533

T-898/OR-10

MODERN EXECUTIVE CHAIR

Burokrat KB-6SL



Modern executive chair Burokrat KB-6SL

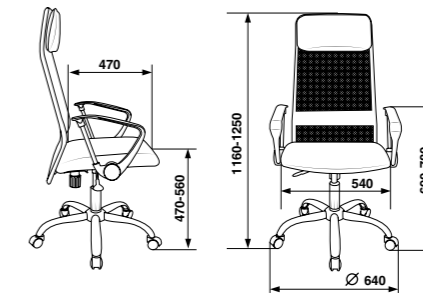

UPHOLSTERY MATERIAL
Mesh/fabric, artificial leather (headrest)

PACKAGE
Weight: 14,22 kr
Volume: 0,143 m³
Dimensions (mm): 875x250x655

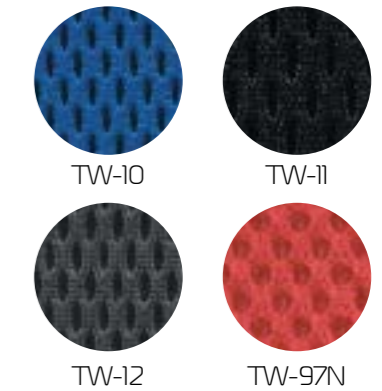
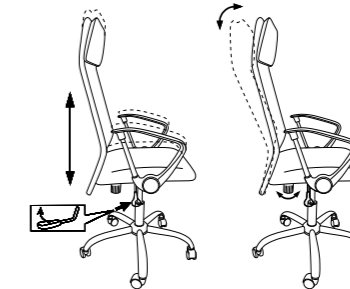

CONSTRUCTION

- Swivel tilting mechanism
- Height adjustment (gas lift)
- Chrome base
- Weight limit - 120 kgs

Item number	PartNo
1027720	KB-6SL/B/TW-11
1051244	KB-6SL/BL/TW-10
1027723	KB-6SL/DG/TW-12
1027721	KB-6SL/R/TW-97N

MODERN EXECUTIVE CHAIR

Burokrat KB-10Lite



Modern executive chair Burokrat KB-10LITE

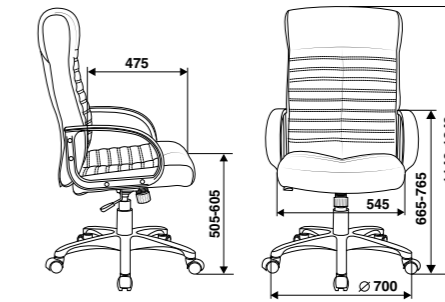

UPHOLSTERY MATERIAL
Artificial leather

PACKAGE
Weight: 15,40 kr
Volume: 0,191 m³
Dimensions (mm):
750x380x670

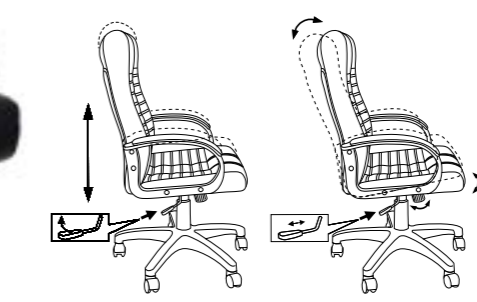

CONSTRUCTION

- Swivel tilting mechanism with weight adjustment, tilting and tilt lock at upright position
- Height adjustment (gas lift)
- Weight limit - 120 kgs



Item number	PartNo
1079069	KB-10LITE/BLACK

**MODERN
EXECUTIVE CHAIR**
Burokrat KB-10



Modern executive chair Burokrat KB-10

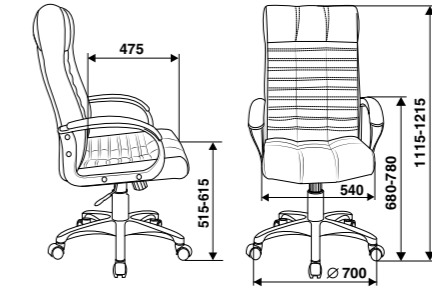

UPHOLSTERY MATERIAL
Artificial leather

PACKAGE
Weight: 16,80 kr
Volume: 0,191 m³
Dimensions (mm):
750x380x670

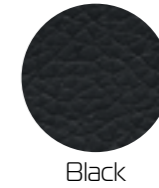
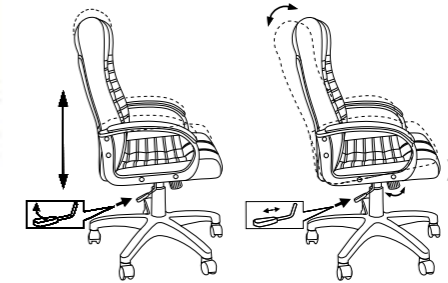

CONSTRUCTION

- Swivel tilting mechanism with weight adjustment, tilting and tilt lock at upright position
- Armrests with soft PU pads
- Height adjustment (gas lift)
- Weight limit - 120 kgs



Item number

PartNo

1004341

KB-10/BLACK

**MODERN
EXECUTIVE CHAIR**
Burokrat DOMINUS



Modern executive chair Burokrat DOMINUS

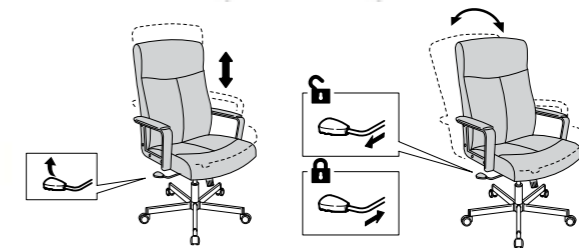

UPHOLSTERY MATERIAL
Fabric

PACKAGE
Weight: 16,09 kr
Volume: 0,095 m³
Dimensions (mm): 750x550x230

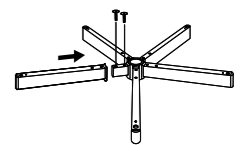
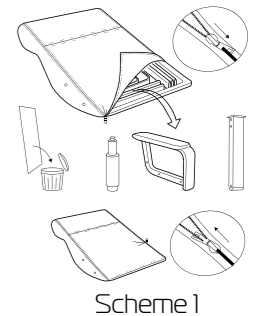

CONSTRUCTION

- Swivel tilting mechanism with weight adjustment, tilting and tilt lock at upright position
- Back cover with fastener: all the chair details are inside (scheme 1)
- Height adjustment (gas lift)
- Sectional metal base
- Castors are with automatic brake: full movement when a chair is occupied, and minimal or no movement when a chair is vacant
- Weight limit - 120 kgs



Grey



Black

Item number **PartNo**

1019312 DOMINUS-FG

1019407 DOMINUS-FB

MODERN EXECUTIVE CHAIR

Burokrat KB-9ECO



Modern executive chair Burokrat KB-9ECO

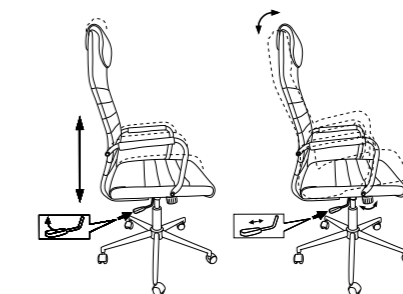
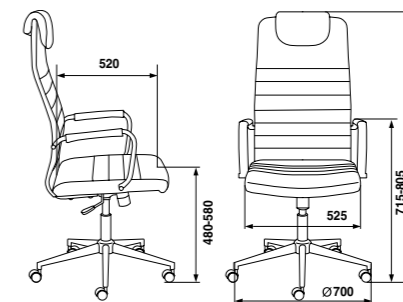

UPHOLSTERY MATERIAL

Artificial leather

PACKAGE

Weight: 15,30 kr

Volume: 0,223 m³

Dimensions (mm):

875x250x655



Black

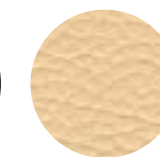

Beige

CONSTRUCTION

- Swivel tilting mechanism with weight adjustment, tilting and tilt lock at upright position
- Height adjustment (gas lift)
- Chrome armrests with PU pads
- Chrome base
- Weight limit - 120 kgs

Item number

PartNo

1008639

KB-9/ECO

1060040

KB-9ECO/OR-12

MODERN CHAIR

Burokrat VIKING-8



Modern chair Burokrat VIKING-8

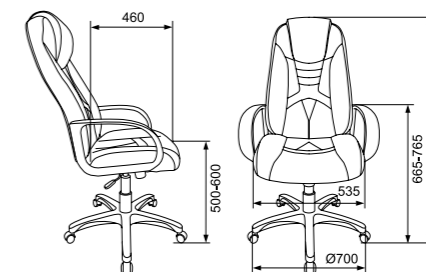

UPHOLSTERY MATERIAL
Artificial leather

PACKAGE

Weight: 15,30 kr

Volume: 0,177 m³

Dimensions (mm): 825x320x670

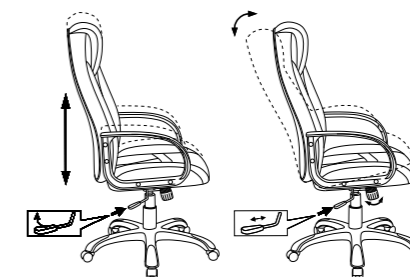

Black

Blue

Red

White

CONSTRUCTION

- Swivel tilting mechanism with weight adjustment, tilting and tilt lock at upright position
- Height adjustment (gas lift)
- Plastic base
- Weight limit - 181 kgs



Item number

PartNo

1078865 VIKING-8/BLACK

1078866 VIKING-8/BL+BLUE

1078867 VIKING-8/BL+RED

1078868 VIKING-8/WH+BLACK

MODERN EXECUTIVE CHAIR

Burokrat CH-823AXSN



Modern executive chair Burokrat CH-823AXSN

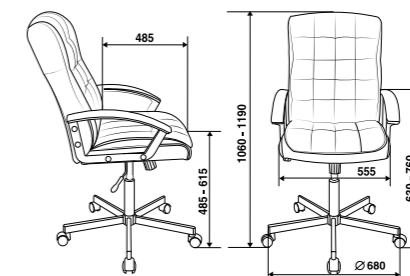

UPHOLSTERY MATERIAL
Artificial leather

PACKAGE

Weight: 16,70 kr
Volume: 0,096 m³
Dimensions (mm): 752x547x233



CONSTRUCTION

- Swivel tilting mechanism with weight adjustment, tilting and tilt lock at upright position
- Armrests with soft PU pads
- Back cover with fastener: all the chair details are inside (scheme 1)
- Height adjustment (gas lift)
- Sectional metal base
- Castors are with automatic brake: full movement when a chair is occupied, and minimal or no movement when a chair is vacant
- Weight limit - 120 kgs



Item number	PartNo
414122	CH-823AXSN/BLACK

MODERN EXECUTIVE CHAIR

Burokrat T-995HOME



Modern executive chair Burokrat T-995HOME

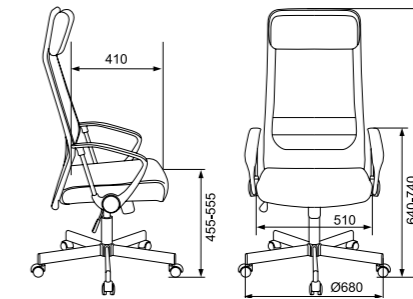

UPHOLSTERY MATERIAL
Fabric, mesh

PACKAGE
Weight: 16,40 kr
Volume: 0,176 m³
Dimensions (mm): 970x330x550

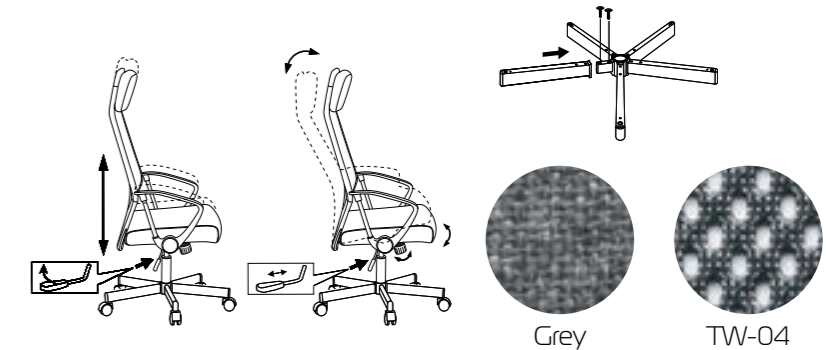

CONSTRUCTION

- Syncro mechanism, synchronized tilting and tilt lock at upright position
- Height adjustment (gas lift)
- Sectional metal base
- Castors are with automatic brake: full movement when a chair is occupied, and minimal or no movement when a chair is vacant
- Weight limit - 120 kgs

Item number PartNo

1050443 T-995HOME/GREY

**MODERN
EXECUTIVE CHAIR**
Burokrat CH-839



Modern executive chair Burokrat CH-839

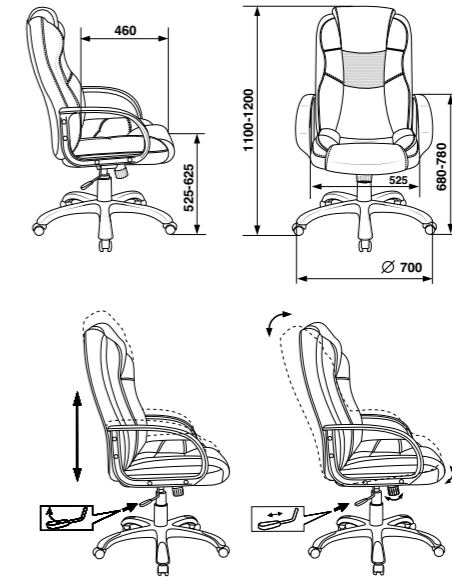

UPHOLSTERY MATERIAL
Artificial leather

PACKAGE
Weight: 15,60 kr
Volume: 0,191 m³
Dimensions (mm):
750x380x670

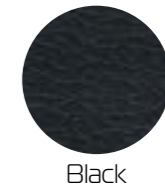

CONSTRUCTION

- Swivel tilting mechanism with weight adjustment, tilting and tilt lock at upright position
- Height adjustment (gas lift)
- Plastic armrests
- Plastic base
- Weight limit - 120 kgs

Item number

PartNo

1088448

CH-839/BLACK

MODERN EXECUTIVE CHAIR

Burokrat CH-868LT



Modern executive chair Burokrat CH-868LT



UPHOLSTERY MATERIAL
Artificial leather

PACKAGE

Weight: 17,36 кг

Volume: 0,191 м3

Dimensions (mm):

750x380x670

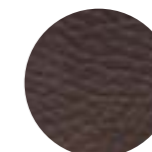
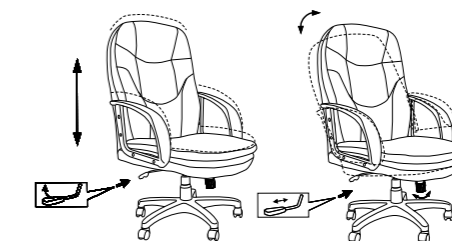

Brown

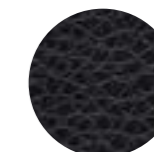

Black

CONSTRUCTION

- Swivel tilting mechanism with weight adjustment, tilting and tilt lock at upright position
- Armrests with soft PU pads
- Height adjustment (gas lift)
- Ограничение по весу: 120 кг



Item number

PartNo

1134799

CH-868LT/#B

1134801

CH-868LT/BROWN

MODERN EXECUTIVE CHAIR

Burokrat T-9910N

Modern executive chair Burokrat T-9910N



UPHOLSTERY MATERIAL

Artificial leather, fabric (inserts)

PACKAGE

Weight: 17,36 kr
Volume: 0,191 m³
Dimensions (mm):
750x380x670

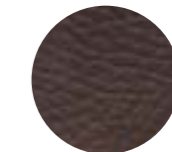
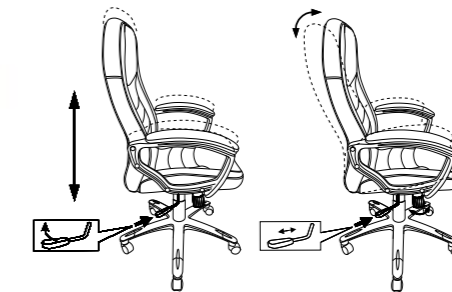

Brown



Black

CONSTRUCTION

- Swivel tilting mechanism with weight adjustment, tilting and tilt lock at upright position
- Plastic armrests with soft PU pads
- Painted plastic base with protective pads
- Height adjustment (gas lift)
- Weight limit - 120 kgs



Item number

PartNo

1106461

T-9910N/BLACK

1106462

T-9910N/BROWN

**MODERN
EXECUTIVE CHAIR**
Burokrat CH-S840N



Modern executive chair Burokrat CH-S840N

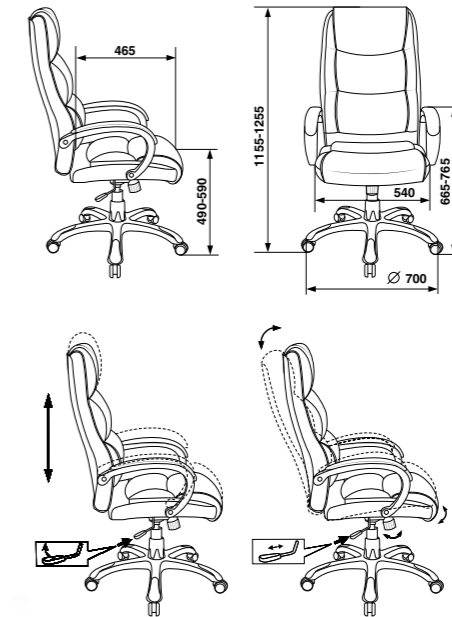

UPHOLSTERY MATERIAL
Artificial leather

PACKAGE
Weight: 19,00 kr
Volume: 0,223 M³
Dimensions (mm):
875x380x670

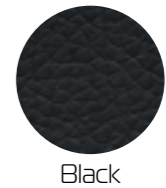

CONSTRUCTION

- Swivel tilting mechanism with weight adjustment, tilting and tilt lock at upright position
- Plastic armrests with PU pads
- Painted plastic base with protective pads
- Height adjustment (gas lift)
- Weight limit - 120 kgs



Item number

PartNo

1100965

CH-S840N/BLACK

MODERN EXECUTIVE CHAIR

Burokrat CH-825A



Modern executive chair Burokrat CH-825A

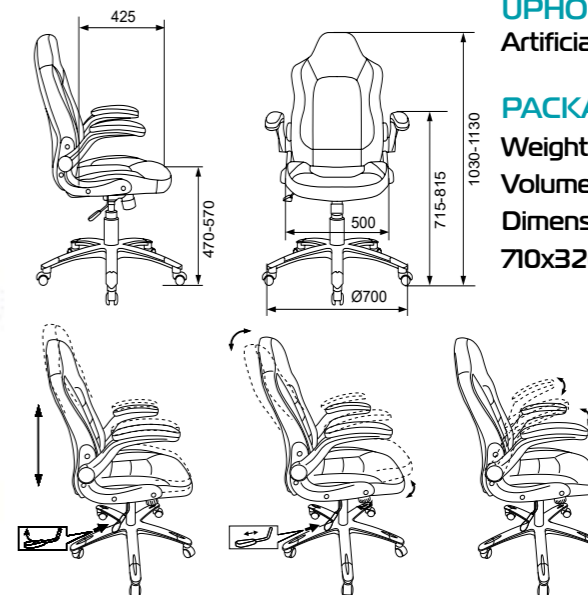

UPHOLSTERY MATERIAL
Artificial leather

PACKAGE

Weight: 15,10 kr
Volume: 0,152 m³
Dimensions (mm):
710x320x670

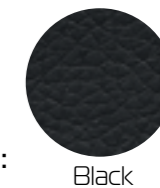

Black



Beige

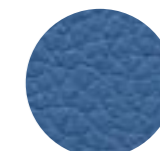

Blue

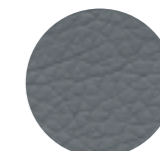

Grey



Red

CONSTRUCTION

- Swivel tilting mechanism with weight adjustment, tilting and tilt lock at upright position
- Folding armrests with soft PU pads
- Painted plastic base with protective pads
- Height adjustment (gas lift)
- Weight limit - 120 kgs



Item number

PartNo

1113573 CH-825A/BLACK+BG

1113576 CH-825A/BLACK+BL

1113578 CH-825A/BLACK+GR

1113580 CH-825A/BLACK+RD

MODERN EXECUTIVE CHAIR

Burokrat CH-824B



Modern executive chair Burokrat CH-824B

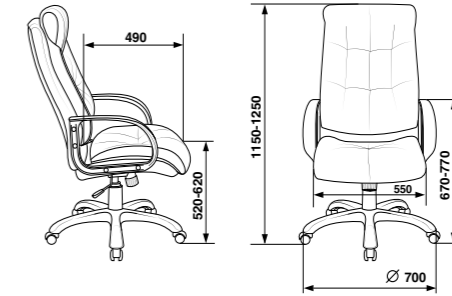

UPHOLSTERY MATERIAL

Artificial leather +
Mesh/fabric
Fabric

PACKAGE

Weight: 16,75 kr
Volume: 0,191 m³
Dimensions (mm):
750x380x670

CONSTRUCTION

- Swivel tilting mechanism with weight adjustment, tilting and tilt lock at upright position
- Plastic armrests
- Height adjustment (gas lift)
- Plastic base
- Weight limit - 120 kgs



Item number

PartNo

1079045 CH-824B/LBLACK

1079046 CH-824B/LGREY

1079043 CH-824B/MF111-2

1079044 CH-824B/F4





Burokrat



www.buro.ru



[buro.ru](https://www.instagram.com/buro.ru)